

## Table of Contents

<b>Contents</b>	2
<b>English</b>	3
<b>iRig Pre HD</b>	3
<b>Register your iRig Pre HD</b>	3
<b>Installation and setup</b>	4
iOS devices	4
MAC/PC	6
<b>iRig Pre HD LEDs</b>	6
Status / Audio level LED	6
Phantom power LED	7
<b>Setting input gain on iRig Pre HD</b>	7
<b>Direct monitoring</b>	8
<b>Stand adapter</b>	8
<b>Troubleshooting</b>	8
<b>Specifications</b>	8
<b>Warranty</b>	9
<b>Support and more info</b>	9

## iRig Pre HD

Thank you for purchasing iRig Pre HD.

Your package contains:

- iRig Pre HD
- 2 AA batteries (alkaline)
- Micro-USB to Lightning cable
- Micro-USB to USB cable
- Velcro strap
- Quick start guide
- Registration card

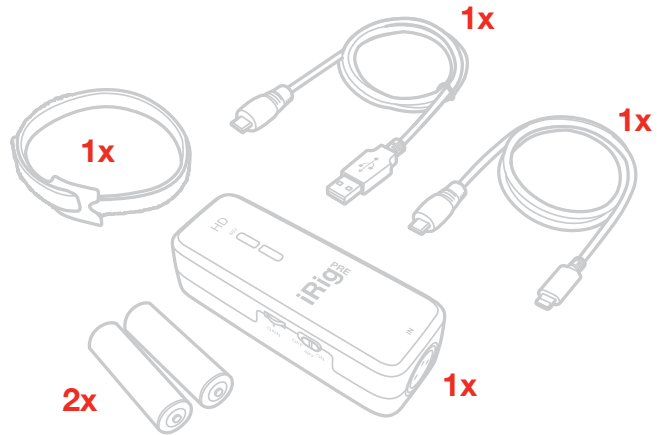

iRig Pre HD is a digital microphone interface for iOS/MAC devices. It features a 3-pin XLR connector for connecting microphones (accepts also phantom powered microphone, thanks to the internal batteries). The new design sports also an Headphones output 1/8" jack to allows to connect your headphone.

## Register your iRig Pre HD

By registering, you can access technical support, activate your warranty and receive free JamPoints™ which will be added to your account. JamPoints™ allow you to obtain discounts on future IK purchases! Registering also keeps you informed of all the latest software updates and IK products.

Register at: [www.ikmultimedia.com/registration](http://www.ikmultimedia.com/registration)

## Installation and setup

**For iOS users:** the internal batteries will power up iRig Pre HD while using a microphone that requires external phantom power.

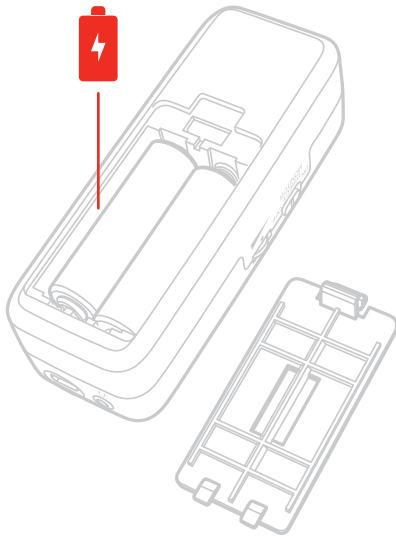

## iOS devices

1. Connect the included Lightning cable to iRig Pre HD Micro-USB port.
2. Connect the Lightning cable to your iOS device. Make sure phantom power is turned off by setting the phantom power switch to the OFF position. Check that the phantom power LED is OFF.

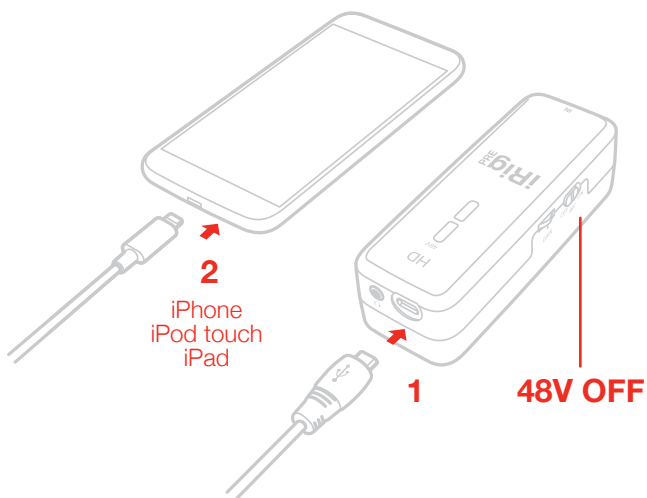

3. If you have not done so already, download your favourite software/app.

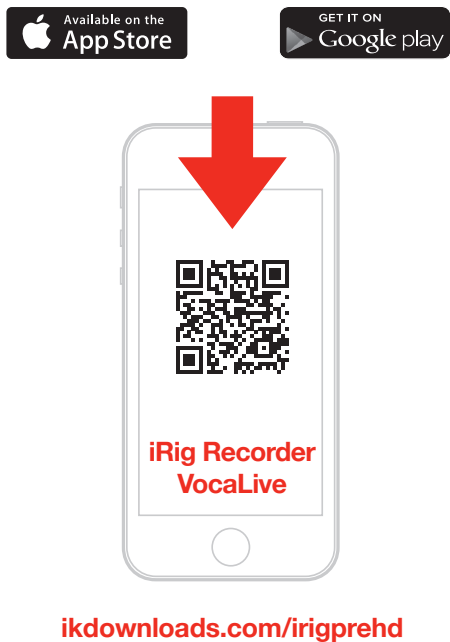

4. If you are using a microphone connect it using an XLR cable to the iRig Pre HD microphone input and set its level via the dedicated gain wheel. If the microphone requires an external power supply, switch ON the phantom power switch.

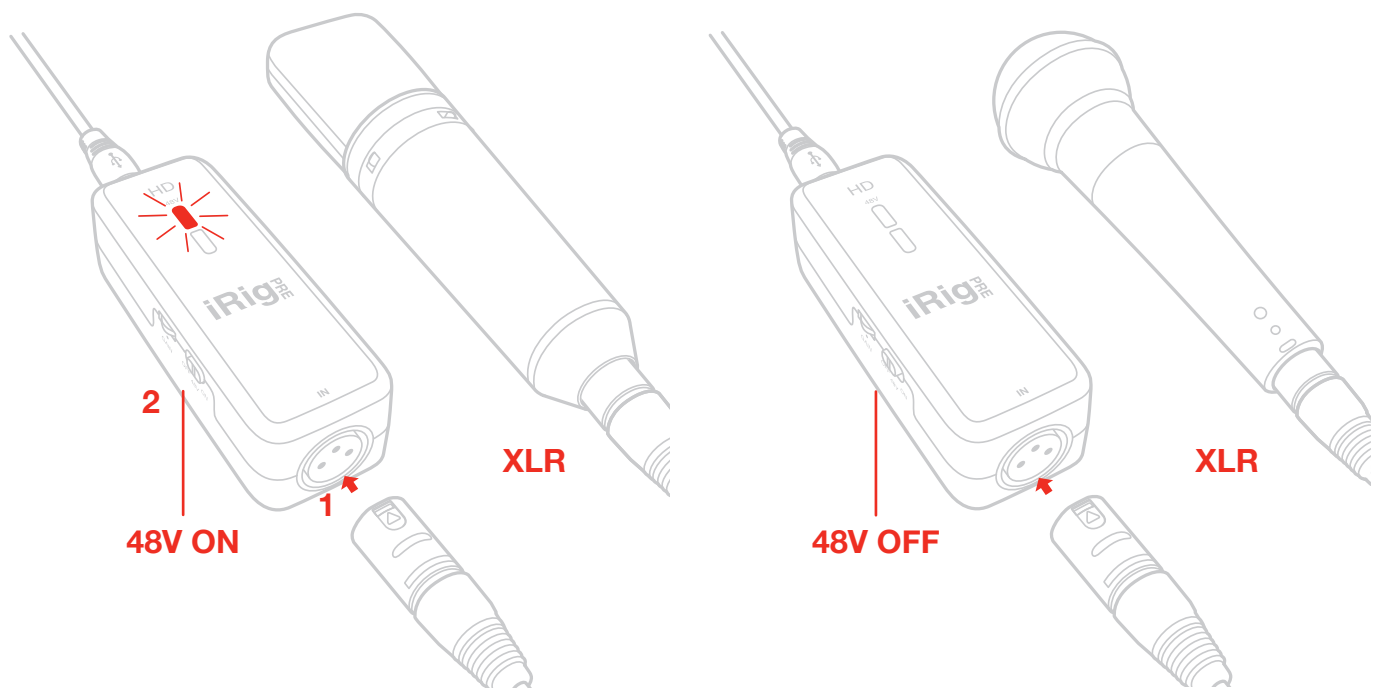

5. Connect your headphones to the Headphone Output jack on iRig Pre HD and set its level with the dedicated volume wheel.

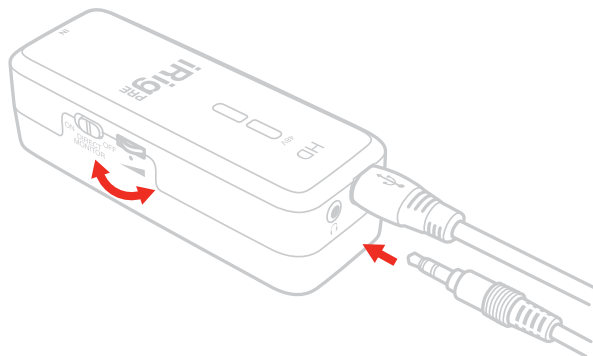

## MAC/PC

1. Connect the included USB cable to iRig Pre HD Micro-USB connector.
2. Connect the USB cable to a free USB port on your Mac/PC.
3. Make sure phantom power is turned off by setting the Phantom Power switch to the OFF position. Check that the phantom power LED is OFF.
4. If you are using a microphone connect it using an XLR cable to one of the iRig Pre HD microphone input and set its level via the dedicated gain wheel.
5. Launch AmpliTube or any other Core Audio-compatible application and select iRig Pre HD as the input device from your system's audio preferences.
6. Connect your headphones to the headphone output jack on iRig Pre HD and set its level with the dedicated volume wheel.

## iRig Pre HD LEDs

### Status / Audio level LED

The lower LED will show the audio signal level and the status of the unit as follow:

- LED Off: iRig Pre HD is not connected to any power source.
- LED Bright blue: iRig Pre HD is connected and a signal is present at the input of the channel.
- LED Green: The input signal of the corresponding channel is low.
- LED Orange: The input signal of the corresponding channel is OK.
- LED Red: The input signal of the corresponding channel is too high.

## Phantom power LED

The upper LED show the phantom power status.

### Phantom LED

- Off: phantom power is OFF.
- Steady Red: phantom power is ON

### LOW BATTERY

When the battery level approach to be low, all the (turned ON) LEDs will fast blink every “2” sec. When the battery is at a very low level the audio out is muted and the LED continuously blinks.

## Setting input gain on iRig Pre HD

When talking or singing into your microphone, check the audio level/status LED on iRig Pre HD.

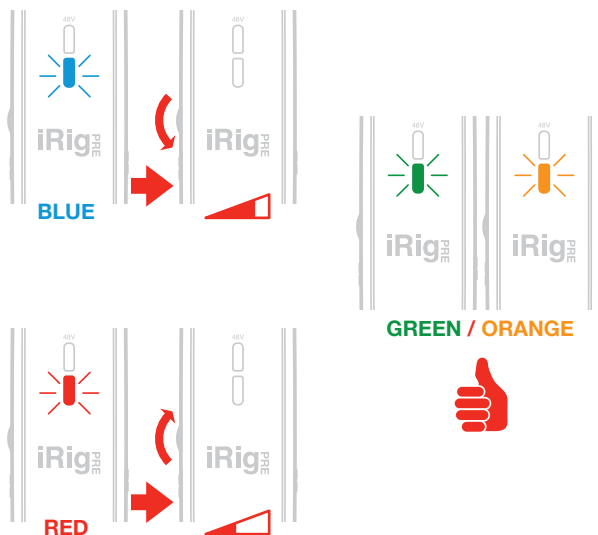

- If the LED is alternating between BLUE and GREEN, or is always GREEN, you should increase the iRig Pre HD input gain by rotating the GAIN control clockwise.
- If the LED sometimes flashes RED, you should decrease the iRig Pre HD input gain by rotating the GAIN control counter-clockwise.
- When your gain setting is optimal, the LED should alternate between GREEN and ORANGE while you play or sing.

## Direct monitoring

When recording an audio signal into your audio software, there is often a slight delay before it reaches the outputs of the software and iRig Pro DUO. This delay, called latency, is caused by the computer processing required to convert and record audio. Since this delay can be distracting, iRig Pro DUO provides a direct monitoring path from the inputs to the outputs, which is activated by the Direct Monitor switch. When Direct Monitoring is enabled, the input signal is mixed with the output signal from your audio software and routed directly to both the Line and Headphone outputs. This lets you hear the “live” inputs without latency. The Direct Monitor switch has no effect on what is being recorded by your software. When using the Direct Monitor feature, make sure any software monitoring option for direct (or “low latency”) monitoring is disabled. Disabling low latency monitoring prevents “double-monitoring” of input audio signals when using the Direct Monitoring feature. When “double-monitoring” occurs, there will be an increase in volume and an undesirable “phasing” sound. For more details about its monitoring function, refer to the documentation for your audio software.

## Stand adapter

You can fix iRig Pre HD to any microphone stand or pole via the included velcro strip.

## Troubleshooting

### Sound is distorted.

You’re probably overloading the input. Check that the input gain on iRig Pre HD is set properly. If the Audio Level LED is red when you play your instrument or sing or talk into a mic, decrease the input gain as described in this guide.

### I don’t get any sound.

In order for iRig Pre HD to turn on, a Core Audio-compatible audio app must first be launched on your iOS device or Mac.

iOS: be sure you are using an app that works with audio input from the Lightning dock connector.

Mac: be sure you have set “iRig Pre HD” as the audio input device on the audio app you are using.

### Phantom power doesn’t turn ON.

Check that you have inserted working AA batteries in iRig Pre HD’s battery compartment.

### I can’t get any sound from my condenser microphone.

Your microphone may need phantom power. Turn phantom power on by moving the iRig Pre HD switch to the ON position and check that the Phantom LED has turned on.

## Specifications

Microphone Input

Microphone Input: balanced female 3-pin, XLR. Pin 2: hot / Pin 3: cold / Pin 1: ground

Microphone Input Level: from 6 mVpp to 1.4 Vpp

Microphone Input Impedance: approx 2 kOhms

Gain Range: 40 dB

Phantom Power: +48V  $\pm$  4V

Frequency Response: 20 Hz - 20 kHz  $\pm$ 1.5dB

Input Noise: -97 dB RMS, -105 dB(A)

Stereo Headphone Output

Connector: 1/8" TRS Jack. Tip: right / Ring: left / Shield: ground

Headphone Level Control numbered thumbwheel

Headphone Level Power 100mW into 50 Ohms

Other Input/Output

Device Connector: micro-USB

Common

Conversion: 24-bit A/D, 24-bit D/A

Sampling Rate: 44.1 kHz, 48 kHz, 88.2 kHz and 96 kHz

Power:

- USB bus powered when used with a computer
- Battery powered (2xAA included) needed for +48V phantom only

## Warranty

Please visit:

[www.ikmultimedia.com/warranty](http://www.ikmultimedia.com/warranty)

for the complete warranty policy.

## Support and more info

[www.ikmultimedia.com/support](http://www.ikmultimedia.com/support)

[www.irigprehd.com](http://www.irigprehd.com)

Apple is not responsible for the operation of this device or its compliance with safety and regulatory standards.